

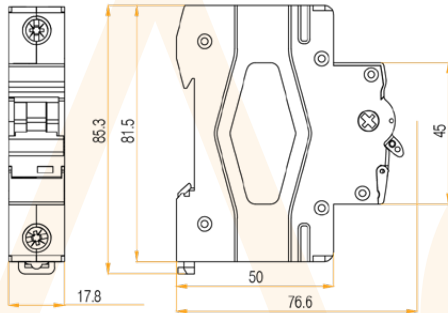

### AC38056

### 1P True 6kA B Curve 40A MCB

- Single Pole
- True 6kA
- B Curve
- Thermal / Magnetic Trip Release
- Large Terminal Capacity
- Lockable switch (with compatible kit)
- Light Grey (RAL 7035)
- 3 year warranty



#### Technical Specification

Overall Dimensions	17.8mm (W) x 85.3mm (H) x 76.6mm (D)
Nominal Voltage	230V/400V~ 50/60Hz
Breaking Capacity	True 6kA
Poles	1
MCB Terminal Capacity	25mm <sup>2</sup> Flexible or 35mm <sup>2</sup> Rigid
MCB Terminal Torque	2.0Nm
Insulation Voltage	500V
Impulse Voltage	4000V
Operational Temp.	-5°C to +40°C

3-AC38056-2022-V1